

General Series SLA Battery

General Series

General Series Valve Regulated Lead Acid batteries are designed with AGM (Absorbent Glass Mat) technology, high performance plates and electrolyte to gain extra power output for common power backup system applications widely used in the field of UPS, Emergency Lighting System.

Application

- Alarm System
- Cable Television
- Communication Equipment
- Control Equipment
- Security System
- Medical Equipment
- UPS
- Power tools
- Emergency Power System
- Toys



General Features

- Sealed and maintenance free operation.
- Non-Spillable construction design.
- ABS containers and covers(UL94HB, UL94V-0) optional.
- Safety valve installation for explosion proof.
- High quality and high reliability.
- Exceptional deep discharge recovery performance.
- Low self discharge characteristic.
- Flexibility design for multiple install positions.

Construction

- ComponentRaw material
- PositiveLead dioxide
- NegativeLead
- ContainerABS
- CoverABS
- SealantEpoxy Resin
- Safety valveEPDR
- TerminalCopper
- SeparatorFiber glass
- ElectrolyteSulfuric acid

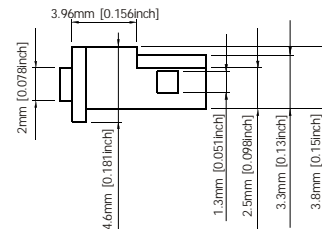
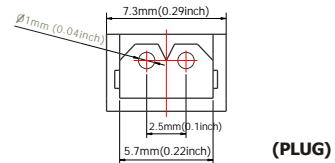

Terminal Dimensions

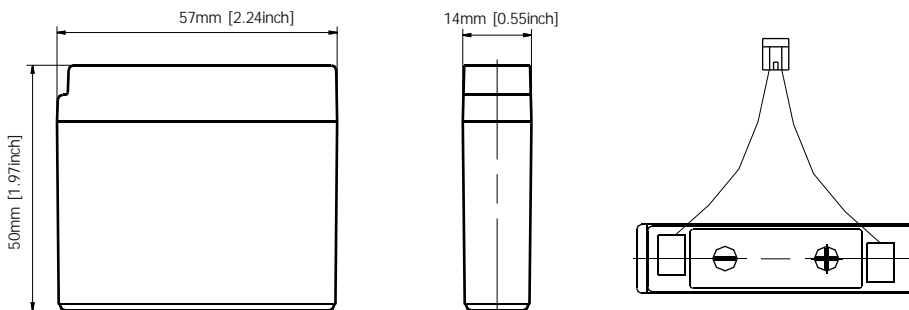

Battery Model	GB6-0.5			
Designed Floating Life	5 Years			
Capacity(25°C)	20HR(0.025A,1.75V)	10HR(0.047A,1.75V)	5HR(0.08A,1.75V)	1HR(0.32A,1.75V)
	0.5AH	0.47AH	0.4AH	0.32AH
Dimensions	Length	Width	Height	Total Height
	57mm(2.25inch)	14mm(0.55inch)	50mm(1.97inch)	53mm(2.09inch)
Approx. Weight	0.11Kg (0.24 lbs)			
Internal Resistance	Full charged at 25°C: 0.136 Ohm			
Self Discharge	3% of capacity declined per month at (25°C)			
Capacity Affected by Temp.(20HR)	40°C	25°C	0°C	-15°C
	102%	100%	85%	65%
Charge Voltage(25°C)	Cycle use		Float use	
	7.2-7.5V(-15mV/ °C), max. Current: 0.15A		6.8-6.9V(-10mV/ °C)	

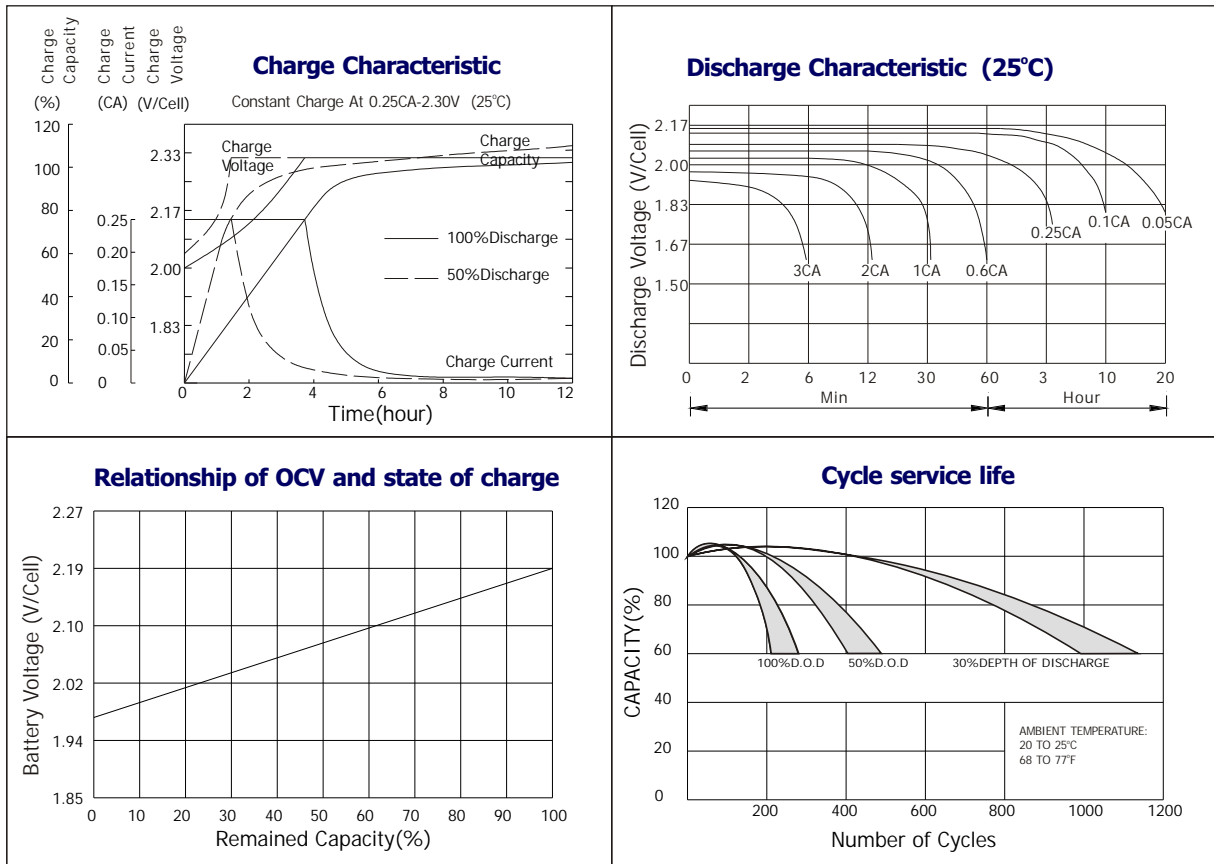

Constant current discharge ratings-amperes at 25°C

F. V / Time	5 MIN	10 MIN	15 MIN	30 MIN	1 HR	3 HR	5 HR	10 HR	20 HR
1.60V	1.76	1.09	0.83	0.50	0.32	0.14	0.086	0.048	0.026
1.67V	1.65	1.04	0.79	0.48	0.32	0.14	0.084	0.048	0.025
1.70V	1.51	1.00	0.78	0.44	0.31	0.13	0.082	0.047	0.025
1.75V	1.48	0.97	0.75	0.42	0.29	0.12	0.080	0.047	0.024
1.80V	1.33	0.93	0.68	0.39	0.27	0.12	0.076	0.046	0.023
1.85V	1.17	0.88	0.61	0.35	0.25	0.11	0.071	0.045	0.023

Constant power discharge ratings-watts at 25°C

F. V / Time	5 MIN	10 MIN	15 MIN	30 MIN	1 HR	3 HR	5 HR	10 HR	20 HR
1.60V	3.08	1.98	1.51	0.91	0.58	0.25	0.15	0.096	0.052
1.67V	2.98	1.93	1.49	0.89	0.57	0.24	0.14	0.095	0.050
1.70V	2.80	1.91	1.48	0.83	0.56	0.23	0.14	0.095	0.049
1.75V	2.82	1.90	1.46	0.81	0.55	0.23	0.14	0.094	0.048
1.80V	2.58	1.87	1.36	0.77	0.52	0.22	0.14	0.092	0.047
1.85V	2.34	1.78	1.23	0.72	0.49	0.21	0.13	0.091	0.045

