

OPzV Series SLA Battery

**Opzv Series**

Bosfa Opzv Series Valve Regulated Lead Acid batteries are designed with a proven combination of GEL and Tubular technologies to offer a very high lever of reliability. Opzv batteries benefit from an optimized plate design which gives capacities in excess of the DIN standard values. In addition, this series offers both a longest float life and a high cycle life in widely industrial field.

**Application**

- |                    |                           |
|--------------------|---------------------------|
| Telecommunications | Medical Equipment         |
| Cable Television   | UPS                       |
| Electric Utility   | Railroad Utility          |
| Control Equipment  | Photovoltaic System       |
| Security System    | Alternative Energy System |

**General Features**

- Sealed and maintenance free operation.
- Non-Spillable construction design.
- ABS containers and covers(UL94HB, UL94V-0) optional.
- Safety valve installation for explosion proof.
- High quality and high reliability.
- Super long service life.
- Lowest self discharge characteristic.
- Super reliability.

**Construction**

- |           |                   |              |                    |
|-----------|-------------------|--------------|--------------------|
| Component | .....Raw material | Sealant      | .....Epoxy Resin   |
| Positive  | .....Lead dioxide | Safety valve | .....EPDR          |
| Negative  | .....Lead         | Terminal     | .....Copper        |
| Container | .....ABS          | Separator    | .....PVC-SiO2      |
| Cover     | .....ABS          | Electrolyte  | .....Sulfuric acid |
|           |                   |              | Thixotropic Gel    |

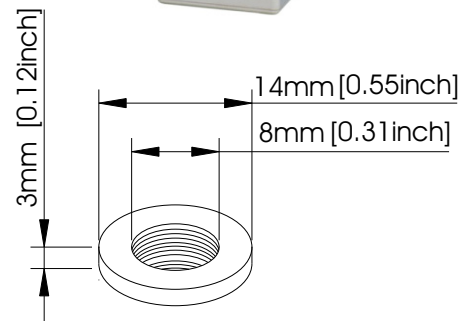

**Terminal Dimensions**

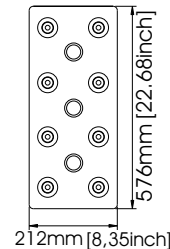
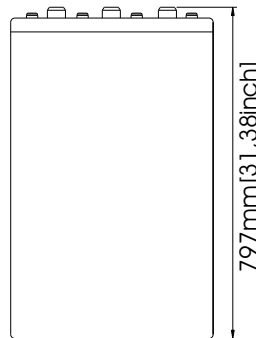
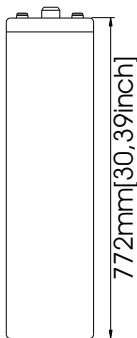

Battery Model	OPzV 2-3000			
Designed Floating Life	15 Years			
Capacity(25°C)	20HR(152A,1.75V)	10HR(300A,1.75V)	5HR(542A,1.75V)	1HR(1950A,1.75V)
	3040AH	3000AH	2710AH	1950AH
Dimensions	Length	Width	Height	Total Height
	576mm(22.68inch)	212mm(8.35inch)	772mm(30.39inch)	797mm(31.38inch)
Approx. Weight	240Kg (529.20 lbs)			
Internal Resistance	Full charged at 25°C: 0.00045 Ohm			
Self Discharge	3% of capacity declined per month at (25°C)			
Capacity Affected by Temp.(20HR)	40°C	25°C	0°C	-15°C
	102%	100%	85%	65%
Charge Voltage(25°C)	Cycle use		Float use	
	2.3V-2.35V(-5mV/ °C), max. Current: 600A		2.25-2.27V(-3.3mV/ °C)	

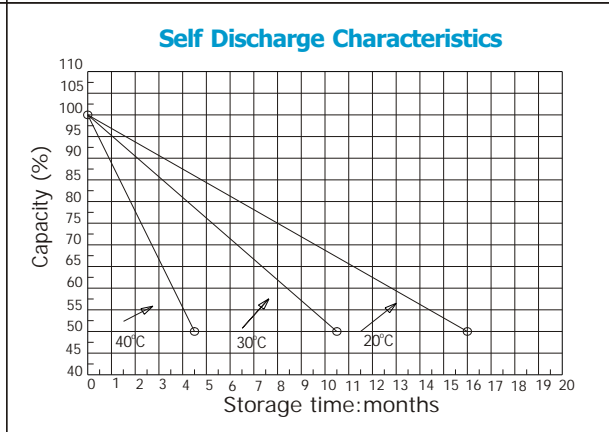
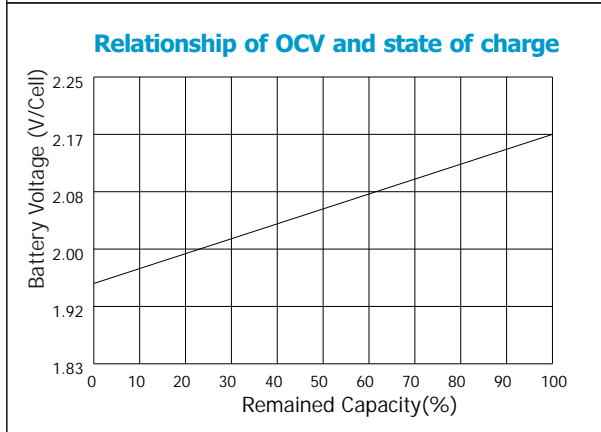
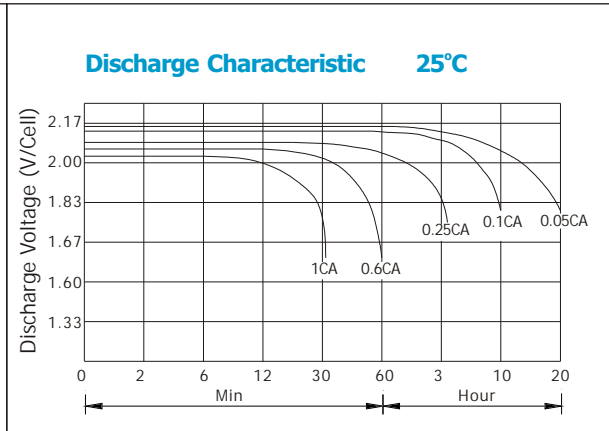
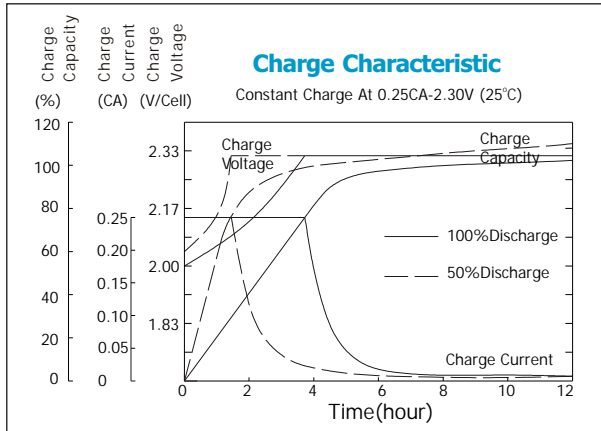

**Constant current discharge ratings-amperes at 25°C**

F.V/Time	15MIN	30MIN	1HR	2HR	3HR	5HR	8HR	10HR	20HR
1.70V	2736	2328	1752	1132	840	557	372	308	188
1.75V	2400	2112	1650	1080	816	544	370	305	185
1.80V	2016	1848	1476	1012	780	526	358	300	179
1.83V	1824	1680	1356	960	744	507	344	288	175
1.87V	1440	1440	1188	864	680	466	326	272	158
1.90V	1200	1200	1044	780	614	423	308	255	149

**Constant power discharge ratings-watts at 25°C**

F.V/Time	15MIN	30MIN	1HR	2HR	3HR	5HR	8HR	10HR	20HR
1.70V	4586	3788	2831	2029	1574	1129	765	598	367
1.75V	4062	3319	2724	2010	1567	1096	742	590	358
1.80V	3302	3165	2453	1969	1506	1059	689	543	325
1.83V	3133	2702	2403	1872	1445	996	659	520	310
1.87V	2504	2462	2351	1658	1307	901	614	503	292
1.90V	2411	2418	2066	1507	1179	775	574	481	282

