

OPzV Series SLA Battery

Opzv Series

Bosfa Opzv Series Valve Regulated Lead Acid batteries are designed with a proven combination of GEL and Tubular technologies to offer a very high lever of reliability. Opzv batteries benefit from an optimized plate design which gives capacities in excess of the DIN standard values. In addition, this series offers both a longest float life and a high cycle life in widely industrial field.

Application

- | | |
|--------------------|---------------------------|
| Telecommunications | Medical Equipment |
| Cable Television | UPS |
| Electric Utility | Railroad Utility |
| Control Equipment | Photovoltaic System |
| Security System | Alternative Energy System |

General Features

- Sealed and maintenance free operation.
- Non-Spillable construction design.
- ABS containers and covers(UL94HB, UL94V-0) optional.
- Safety valve installation for explosion proof.
- High quality and high reliability.
- Super long service life.
- Lowest self discharge characteristic.
- Super reliability.

Construction

- | | | | |
|-----------|-------------------|--------------|--------------------|
| Component |Raw material | Sealant |Epoxy Resin |
| Positive |Lead dioxide | Safety valve |EPDR |
| Negative |Lead | Terminal |Copper |
| Container |ABS | Separator |PVC-SiO2 |
| Cover |ABS | Electrolyte |Sulfuric acid |
| | | | Thixotropic Gel |

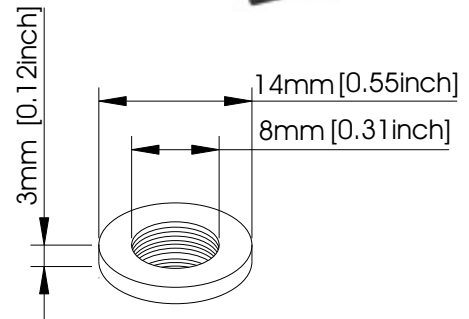

Terminal Dimensions

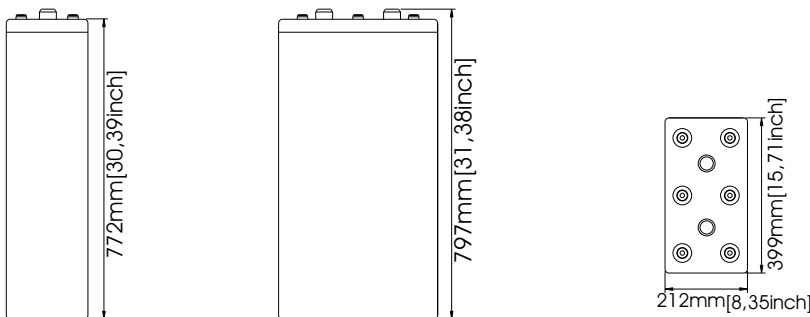

Battery Model	OPzV 2-2000			
Designed Floating Life	15 Years			
Capacity(25°C)	20HR(102A,1.75V)	10HR(200A,1.75V)	5HR(347A,1.75V)	1HR(1295A,1.75V)
	2040AH	2000AH	1735AH	1295AH
Dimensions	Length	Width	Height	Total Height
	399mm(15.71inch)	212mm(8.35inch)	772mm(30.39inch)	797mm(31.38inch)
Approx. Weight	160Kg (352.80 lbs)			
Internal Resistance	Full charged at 25°C: 0.0005 Ohm			
Self Discharge	3% of capacity declined per month at (25°C)			
Capacity Affected by Temp.(20HR)	40°C	25°C	0°C	-15°C
	102%	100%	85%	65%
Charge Voltage(25°C)	Cycle use		Float use	
	2.3V-2.35V(-5mV/ °C), max. Current: 400A		2.25-2.27V(-3.3mV/ °C)	

OPzV Series SLA Battery

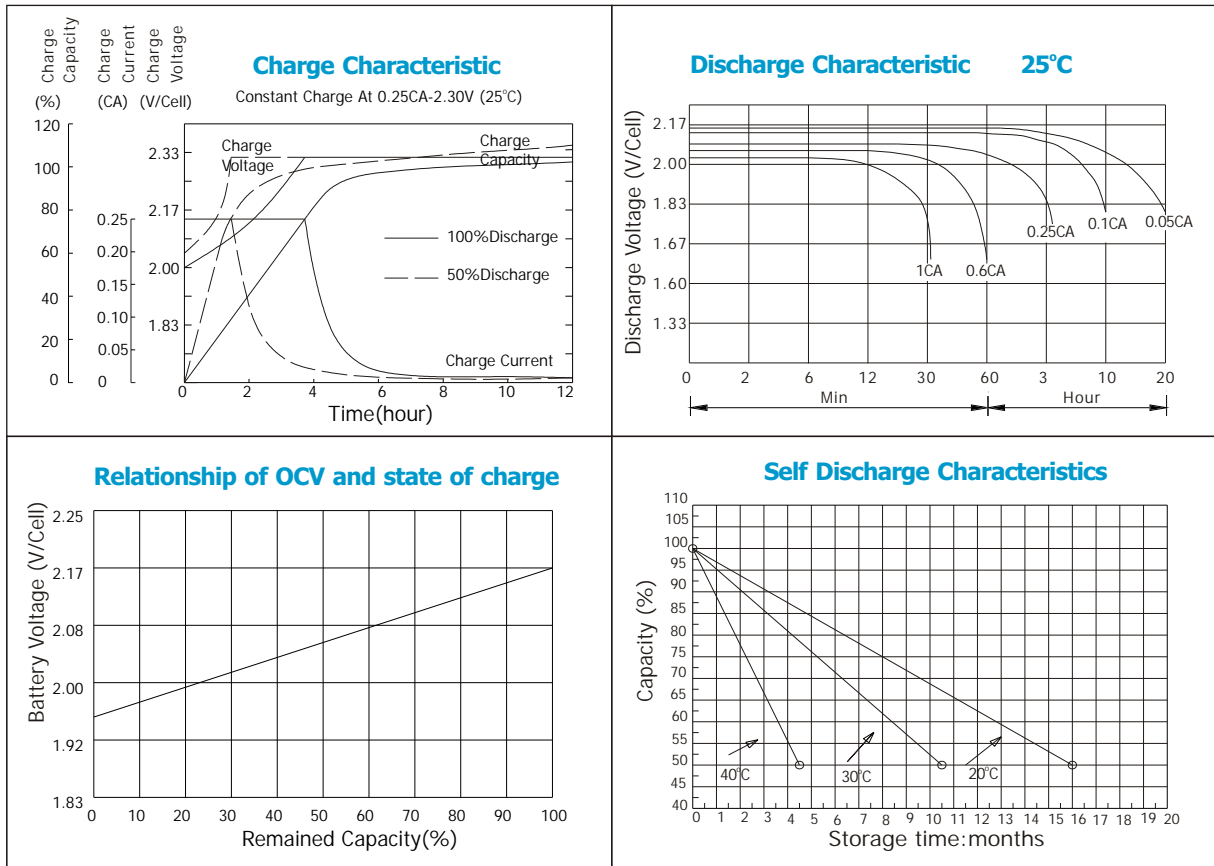

Constant current discharge ratings-amperes at 25°C

F.V/Time	15MIN	30MIN	1HR	2HR	3HR	5HR	8HR	10HR	20HR
1.70V	1824	1552	1168	756	560	372	248	205	125
1.75V	1600	1408	1100	720	544	363	246	204	124
1.80V	1344	1232	984	676	520	351	239	200	120
1.83V	1216	1120	904	640	496	338	229	192	116
1.87V	960	960	792	576	453	311	218	181	105
1.90V	800	800	696	520	410	282	205	170	99.9

Constant power discharge ratings-watts at 25°C

F.V/Time	15MIN	30MIN	1HR	2HR	3HR	5HR	8HR	10HR	20HR
1.70V	3057	2525	1887	1354	1050	752	510	398	243
1.75V	2708	2212	1815	1396	1044	732	495	392	238
1.80V	2201	2109	1636	1314	1003	707	460	362	216
1.83V	2090	1801	1603	1248	964	666	439	362	205
1.87V	1669	1641	1566	1105	872	600	408	335	195
1.90V	1608	1610	1378	1005	788	518	383	322	189

