

OPzS Series SLA Battery

Opzs Series

Bosfa Opzs Series Lead Acid batteries are designed with a combination of die-casting Tubular positive framework and superfluous electrolyte technologies to offer a very high lever of reliability and a long service life. Opzs batteries used special filter and proof design to ensure no acid fog runs over and burning proof, and also convenient examine and maintenance.

Application

- | | |
|--------------------|---------------------------|
| Telecommunications | Medical Equipment |
| Cable Television | UPS |
| Electric Utility | Railroad Utility |
| Control Equipment | Photovoltaic System |
| Security System | Alternative Energy System |



General Features

- Maintenance convenient.
- Non-Spillable construction design.
- Transparent containers, convenient to observe.
- Special filter installation for acid fog proof.
- High quality and high reliability.
- Super long service life.
- Special pole sealed technology.
- Super reliability.

Construction

- | | | | |
|-----------|-------------------|-------------|--------------------|
| Component |Raw material | Terminal |Copper |
| Positive |Lead dioxide | Separator |Rubber-PVC |
| Negative |Lead | Electrolyte |Sulfuric acid |
| Container |AS | | |
| Cover |AS | | |

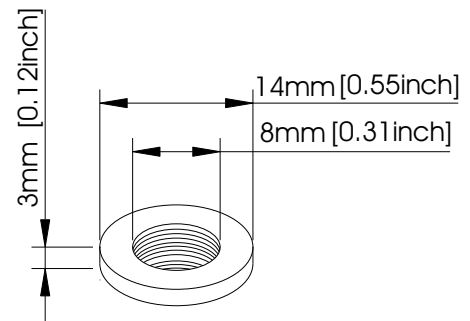

Terminal Dimensions

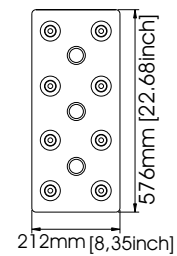
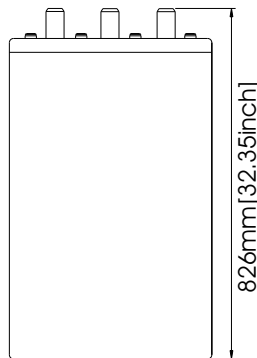
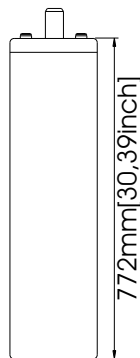

Battery Model	OPzS 2-3000			
Designed Floating Life	15 Years			
Capacity(25°C)	24HR(150A,1.85V)	10HR(300A,1.80V)	5HR(504A,1.77V)	1HR(1488A,1.67V)
	3600AH	3000AH	2520AH	1488AH
Dimensions	Length	Width	Height	Total Height
	576mm(22.68inch)	212mm(8.35inch)	771mm(30.35inch)	826mm(32.35inch)
Approx. Weight	Without electrolyte:179 Kg (394.7 lbs)		with electrolyte: 242 Kg (533.6 lbs)	
Internal Resistance	Full charged at 25°C: 0.00045 Ohm			
Self Discharge	3% of capacity declined per month at (25°C)			
Capacity Affected by Temp.(20HR)	40°C	25°C	0°C	-15°C
	102%	100%	85%	65%
Charge Voltage(25°C)	Cycle use		Float use	
	2.35V-2.4V(-5mV/ °C), max. Current: 450A		2.24V(-3.3mV/ °C)	

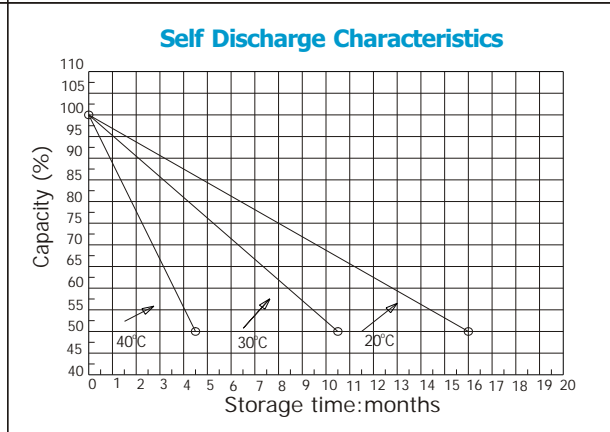
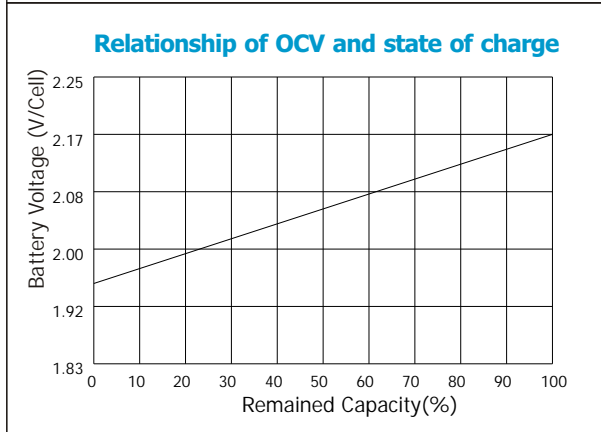
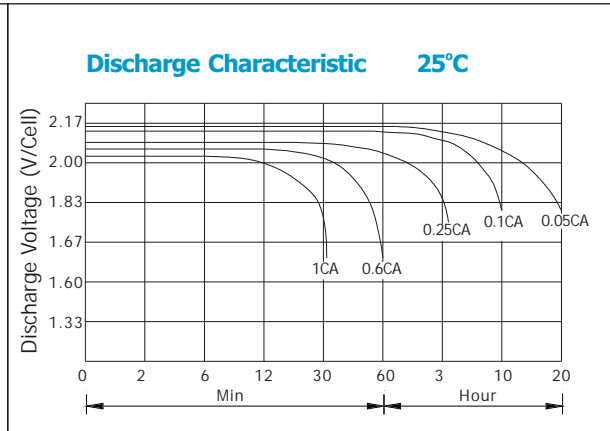
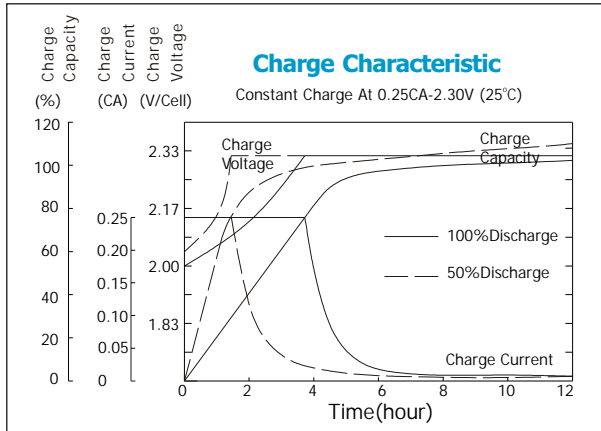

Constant current discharge ratings-amperes at 25°C

TIME	1HR	3HR	5HR	10HR	24HR	48HR	72HR	96HR	120HR	240HR
CUT-OFF VOLTAGE	1.67	1.75	1.77	1.80	1.85	1.85	1.85	1.85	1.85	1.85
CAPACITY(AH)	1488	2232	2520	3000	3600	4020	4200	4220	4250	4330

Constant power discharge ratings-watts at 25°C

TIME	1HR	3HR	5HR	10HR	24HR	48HR	72HR	96HR	120HR	240HR
CUT-OFF VOLTAGE	1.67	1.75	1.77	1.80	1.85	1.85	1.85	1.85	1.85	1.85
CAPACITY(WH)	2098	3527	3982	4560	5004	5588	5838	5866	5908	6019

