

**OPzS Series SLA Battery**

**Opzs Series**

Bosfa Opzs Series Lead Acid batteries are designed with a combination of die-casting Tubular positive framework and superfluous electrolyte technologies to offer a very high lever of reliability and a long service life. Opzs batteries used special filter and proof design to ensure no acid fog runs over and burning proof, and also convenient examine and maintenance.

**Application**

- |                    |                           |
|--------------------|---------------------------|
| Telecommunications | Medical Equipment         |
| Cable Television   | UPS                       |
| Electric Utility   | Railroad Utility          |
| Control Equipment  | Photovoltaic System       |
| Security System    | Alternative Energy System |



**General Features**

- Maintenance convenient.
- Non-Spillable construction design.
- Transparent containers, convenient to observe.
- Special filter installation for acid fog proof.
- High quality and high reliability.
- Super long service life.
- Special pole sealed technology.
- Super reliability.

**Construction**

- |                 |              |                   |               |
|-----------------|--------------|-------------------|---------------|
| Component ..... | Raw material | Terminal .....    | Copper        |
| Positive .....  | Lead dioxide | Separator .....   | Rubber-PVC    |
| Negative .....  | Lead         | Electrolyte ..... | Sulfuric acid |
| Container ..... | AS           |                   |               |
| Cover .....     | AS           |                   |               |

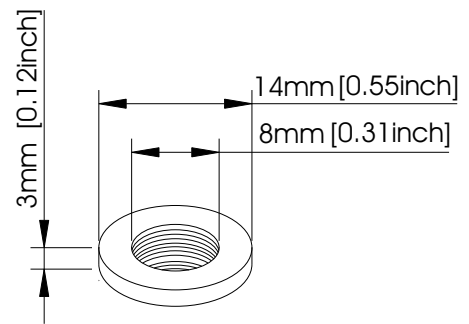

**Terminal Dimensions**

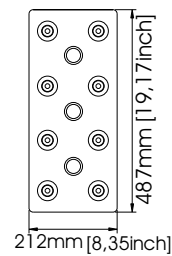
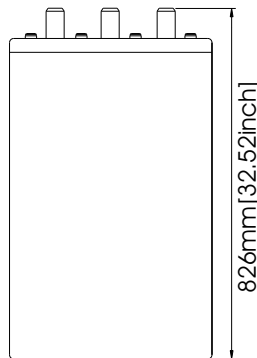

Battery Model	OPzS 2-2250			
Designed Floating Life	15 Years			
Capacity(25°C)	24HR(112.5A,1.85V)	10HR(225A,1.80V)	5HR(387A,1.77V)	1HR(1125A,1.67V)
	2700AH	2250AH	1935AH	1125AH
Dimensions	Length	Width	Height	Total Height
	487mm(19.17inch)	212mm(8.53inch)	771mm(30.35inch)	826mm(32.52inch)
Approx. Weight	Without electrolyte:142 Kg (313.1 lbs)		with electrolyte: 195 Kg (430 lbs)	
Internal Resistance	Full charged at 25°C: 0.0005 Ohm			
Self Discharge	3% of capacity declined per month at (25°C)			
Capacity Affected by Temp.(20HR)	40°C	25°C	0°C	-15°C
	102%	100%	85%	65%
Charge Voltage(25°C)	Cycle use		Float use	
	2.35V-2.4V(-5mV/ °C), max. Current: 337.5A		2.24V(-3.3mV/ °C)	

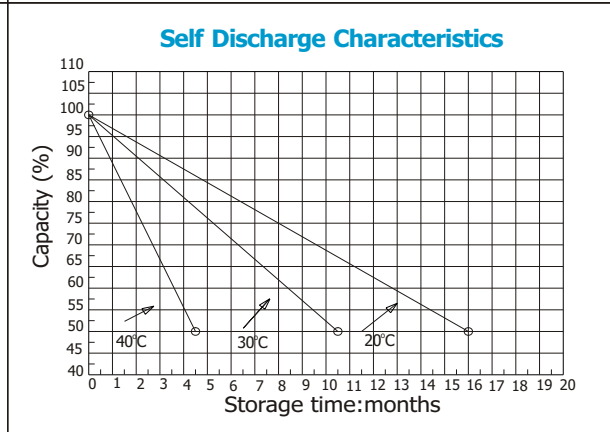
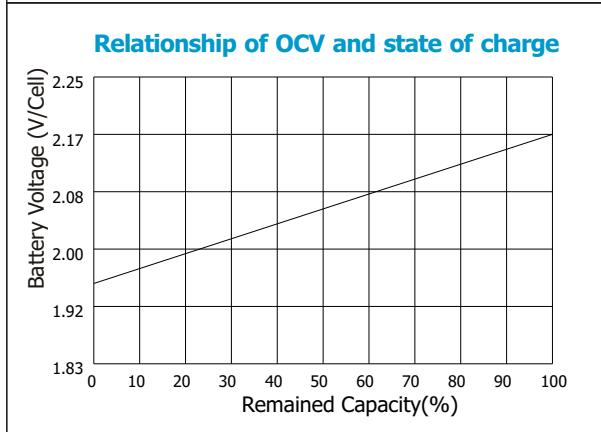
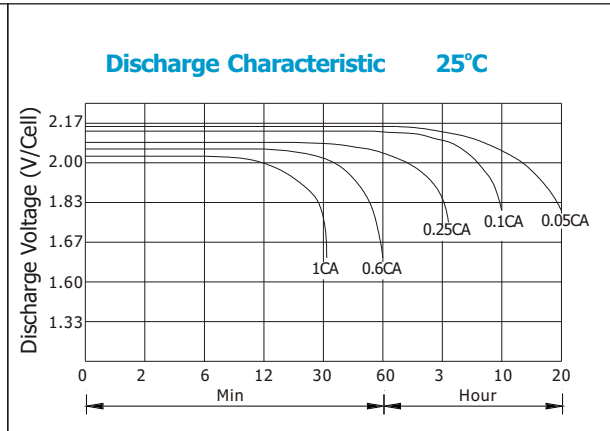
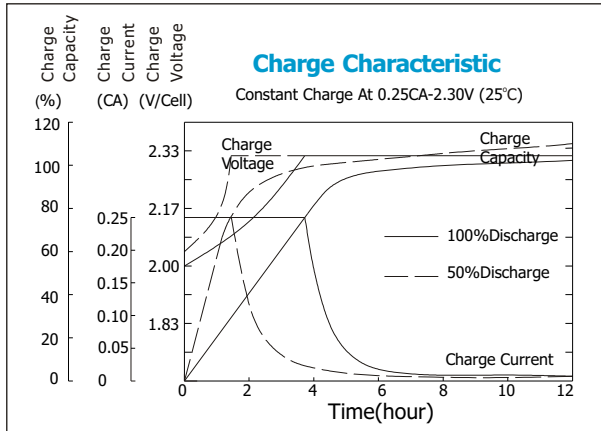

**Constant current discharge ratings-amperes at 25°C**

TIME	1HR	3HR	5HR	10HR	24HR	48HR	72HR	96HR	120HR	240HR
CUT-OFF VOLTAGE	1.67	1.75	1.77	1.80	1.85	1.85	1.85	1.85	1.85	1.85
CAPACITY(AH)	1125	1686	1935	2250	2700	3015	3150	3160	3170	3230

**Constant power discharge ratings-watts at 25°C**

TIME	1HR	3HR	5HR	10HR	24HR	48HR	72HR	96HR	120HR	240HR
CUT-OFF VOLTAGE	1.67	1.75	1.77	1.80	1.85	1.85	1.85	1.85	1.85	1.85
CAPACITY(WH)	1485	2866	3212	3578	3942	4402	4599	4614	4628	4716

